

OPzV2-420(2V420Ah)



OPzV series is Valve Regulated Lead Acid battery that adopts immobilized GEL and Tubular Plate technology to offer high reliability and performance. The Battery is designed and manufactured according to DIN standards and with die-casting positive grid and patented formula of active material OPzV series exceeds DIN standard values with more than 20 years floating design life at 25 °C and It is the best solution for cyclic use under extreme operating conditions.



Specification

Cells Per Unit	1
Voltage Per Unit	2
Nominal Capacity	420Ah@10hr-rate to 1.80V per cell @25°C
Weight	Approx. 32.5Kg (Tolerance±3.0%)
Internal Resistance	Approx. 0.75mΩ
Terminal	F10(M8)
Max. Discharge Current	1700A (5 sec)
Design Life	20 years (floating charge)
Max. Charging Current	84.0 A
Reference Capacity	C3 322.5AH C5 364.6AH C10 420.0AH C20 447.6AH
Float Charging Voltage	2.25 V~2.30 V @ 25°C Temperature Compensation: -3mV/°C/Cell
Cycle Use Voltage	2.37 V~2.40 V @ 25°C Temperature Compensation: -4mV/°C/Cell
Operating Temperature Range	Discharge: -40°C~60°C Charge: -20°C~50°C Storage: -40°C~60°C
Normal Operating Temperature Range	25°C±5°C
Self Discharge	RITAR Valve Regulated Lead Acid (VRLA) batteries can be stored for up to 6 months at 25°C and then recharging is recommended. Monthly Self-discharge ratio is less than 2% at 20°C. Please charged batteries before using.
Container Material	A.B.S. UL94-HB, UL94-V0 Optional.

Dimensions

Unit: mm

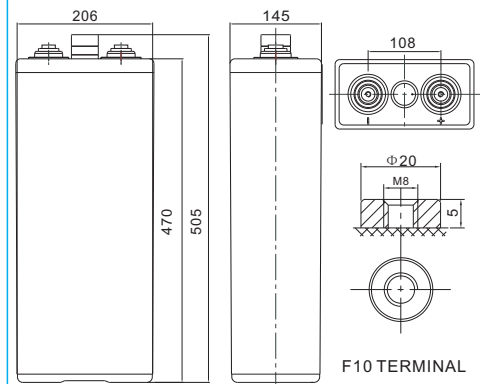

Length	145±2mm (5.71 inches)
Width	206±2mm (8.11 inches)
Height	470±2mm (18.5 inches)
Total Height	505±2mm (19.9 inches)
Torque Value	10~12 N*m

Constant Current Discharge Characteristics : A(25°C)

F.V/ Time	10min	15min	30min	1h	2h	3h	5h	8h	10h	20h
1.60V	660.6	528.7	359.8	237.7	151.6	112.9	75.85	52.40	43.89	23.04
1.65V	631.0	509.7	351.4	234.1	149.3	111.7	75.22	51.98	43.47	22.82
1.70V	588.8	484.4	338.8	228.0	146.8	109.6	73.97	51.35	43.26	22.71
1.75V	523.4	442.3	319.8	218.6	143.3	107.5	72.92	50.72	42.63	22.38
1.80V	443.2	396.0	298.8	210.2	138.5	105.2	71.46	49.88	42.00	22.05
1.85V	360.9	326.5	256.7	187.6	126.3	96.66	66.24	46.53	39.27	20.62

Constant Power Discharge Characteristics : WPC(25°C)

F.V/ Time	10min	15min	30min	1h	2h	3h	5h	8h	10h	20h
1.60V	1122.8	924.7	654.4	445.6	287.8	216.0	146.9	102.7	86.73	45.53
1.65V	1095.3	905.7	646.0	440.8	285.3	214.8	145.8	102.3	86.10	45.20
1.70V	1038.4	869.9	627.1	432.4	280.5	211.2	144.6	101.2	85.47	44.87
1.75V	941.3	808.8	597.6	418.1	274.4	207.7	142.3	100.2	84.63	44.43
1.80V	810.4	733.0	566.0	404.9	268.6	204.2	139.8	98.71	83.37	43.77
1.85V	671.1	615.0	490.3	361.9	245.6	188.5	130.2	92.42	78.33	41.12

(Note) The above characteristics data are average values obtained within three charge/discharge cycle not the minimum values.

The battery must be fully charged before the capacity test. The C₁₀ should reach 95% after the first cycle and 100% after the third cycle.

OPzV2-420(2V420Ah)



Discharge Characteristics Curve

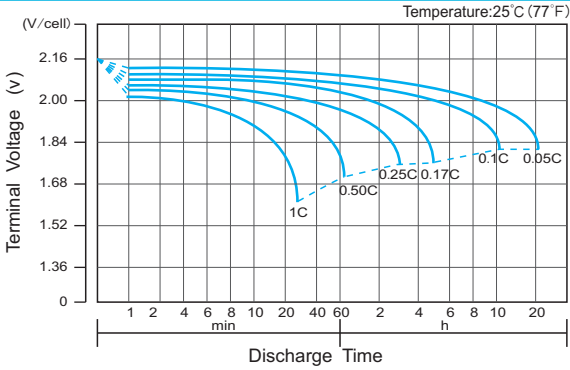

Charge Characteristic Curve for Cycle Use(IU)

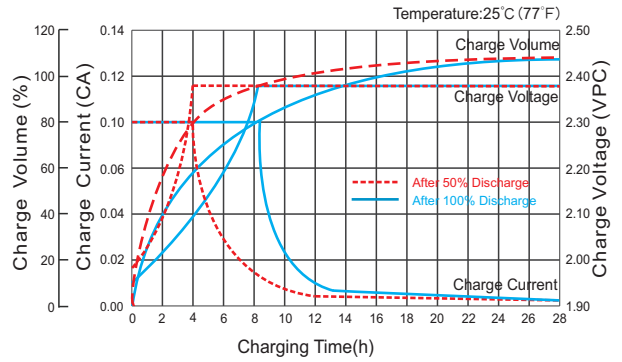

Cycle Life in Relation to Depth of Discharge

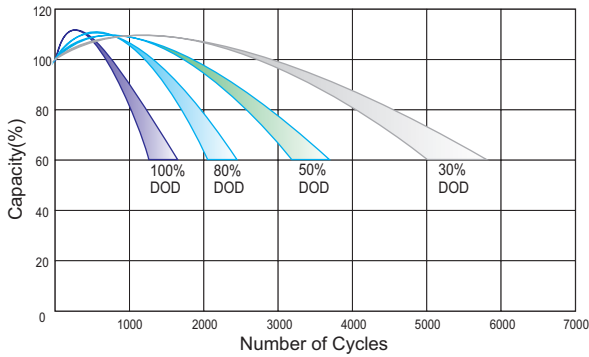

Relationship Between Charging Voltage and Temperature

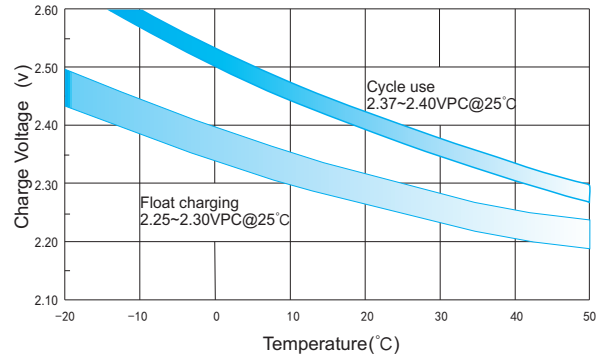

Temperature Effects on Capacity

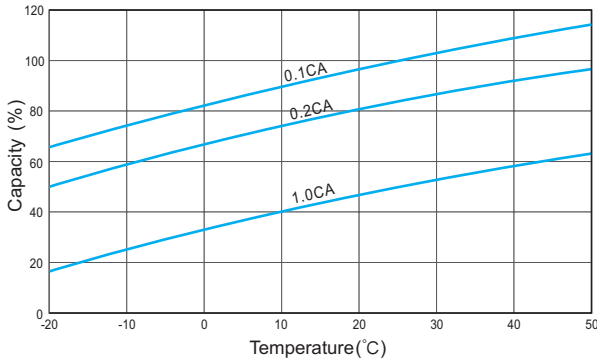

Storage Characteristics

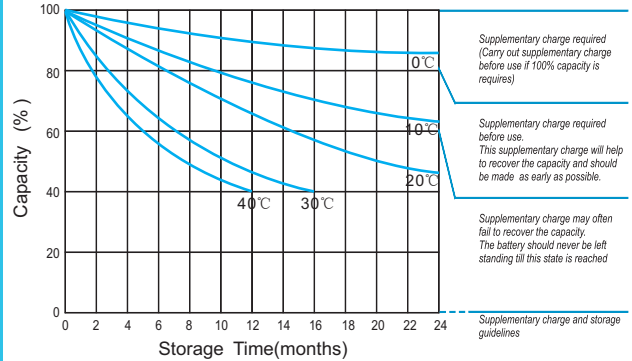

Effect of Temperature on Long Term Life

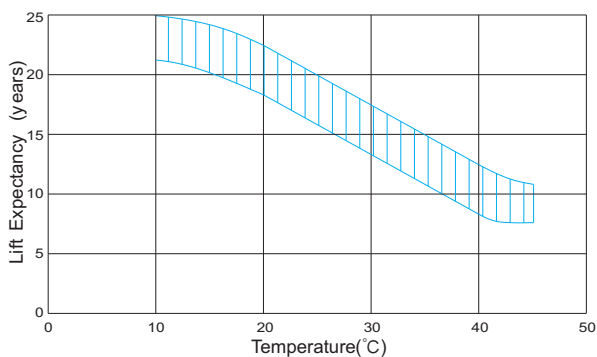

Relationship of OCV And State of Charge(20°C)



(Note) All above information shall be changed without prior notice, Ritar reserves the right to explain and update the latest information.